

Article number: 204150M1675D1T
 Description: E+G levelling foot
 GN 41-50-M16-75-D1-T
 Note: T Without nut, Wrench flat at the bottom

Measures

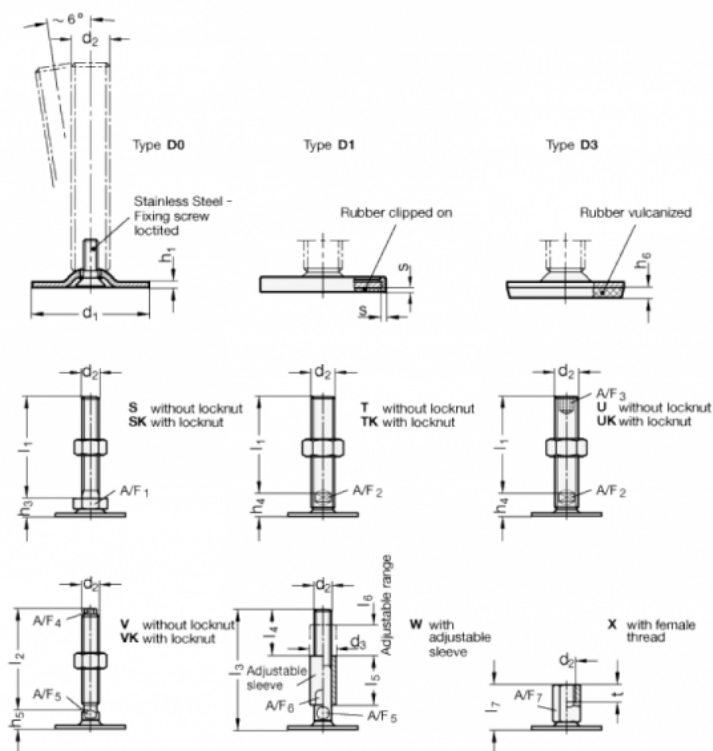

- A/F2 = 12
- d1 = 50
- d2 = M16
- h1 = 2.5
- h4 = 17
- h6 =
- l1 = 75
- s = 2